

ELECTRICAL SPECIFICATIONS

Nominal Voltage	12.8 V
Nominal Capacity	75 Ah
Capacity @ 25A	180 min
Resistance	≤30 mΩ @ 50% SOC
Efficiency	99%
Self Discharge	<3% per Month
Maximum Modules in Parallel or Series	4

CHARGING CHARACTERISTICS

Recommended Charge Current	≤ 35 A
Maximum Charge Current	75 Ah
Floating Charge Voltage	13.8 ±0.2 V
Maximum Charge Voltage	14.6 ±0.2 V
Recommended Charge Voltage (Single Unit)	14.4 V - 14.6 V
BMS Charge Voltage Cut-Off	14.8 V
Reconnect Voltage	14.4 V
Balancing Voltage	13.6 V ± 0.2 V

DISCHARGE SPECIFICATIONS

Maximum Continuous Discharge Current	75 A
Peak Discharge Current	170 A For 3 S
Recommended Low Voltage Disconnect	10 V ± 0.04 V
BMS Discharge Voltage Cut-Off	10 V ± 0.2 V
Reconnect Voltage	11.2 V ± 0.04 V
Short Circuit Protection	200-600 μs

TEMPERATURE SPECIFICATIONS

Discharge Temperature	-20 to 60 °C (-4 to 140 °F)
Charge Temperature*	0 to 45 °C (32 to 113 °F)
Recommended Storage Temperature	-5 to 35 °C (23 to 95 °F)
BMS High Temperature Cut-Off	65 °C (149 °F)
Reconnect Temperature	50 °C (122 °F)

*32°F = 0°C

MECHANICAL SPECIFICATIONS

Dimensions (L x W x H)	10.24 x 6.61 x 8.39" 260 x 168 x 213 mm
Weight	21.2 lbs (9.62 kg)
Terminal / Thread Pitch	M6 / 1
Bolt Length / Thread Depth	12mm / 10mm
Case Material / Torque	ABS / 35 -44 in-lbs (4-5 N-m)
IP Rating	IP55
Cell Type - Chemistry	Prismatic - LiFePO4

DIMENSIONAL SPECIFICATIONS

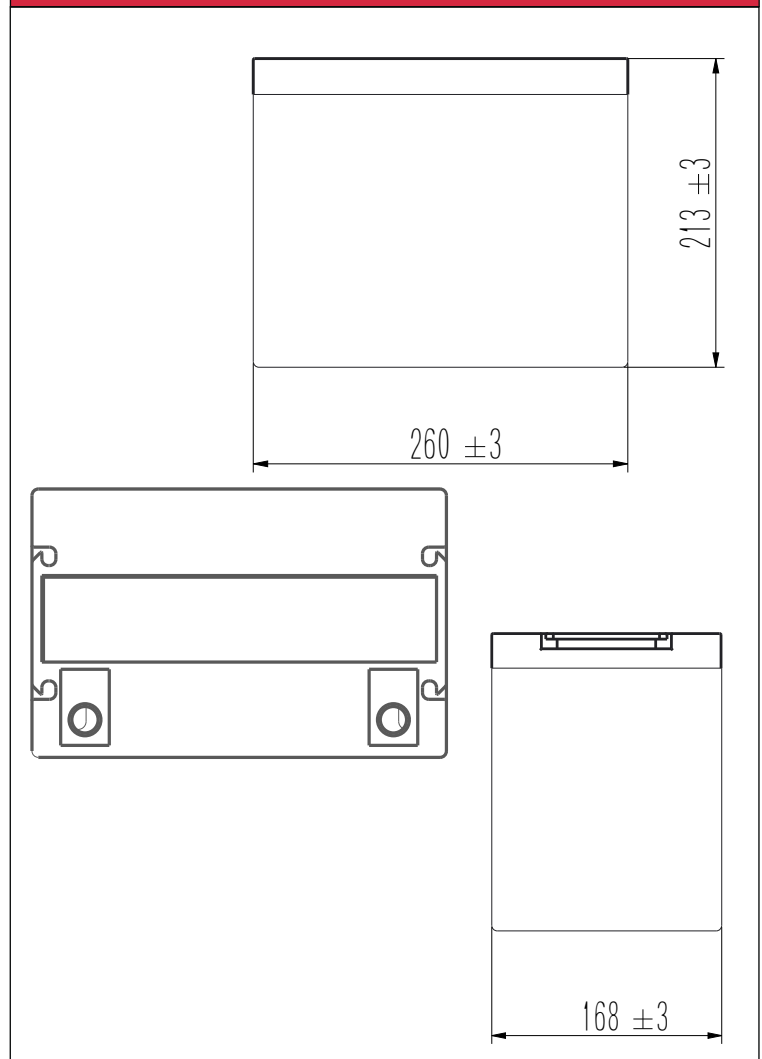

To ensure safe and efficient operation always refer to the latest edition of our datasheets, as published on our website www.canbat.com. Canbat Technologies Inc. All rights reserved. All trademarks are the property of their respective owners. All data subject to change without notice. E&O.E



CANBAT

Model: CLI75-12 | Voltage: 12.8V | Capacity: 75Ah | Energy: 960Wh

DIFFERENT RATE DISCHARGE CURVE (25°C)

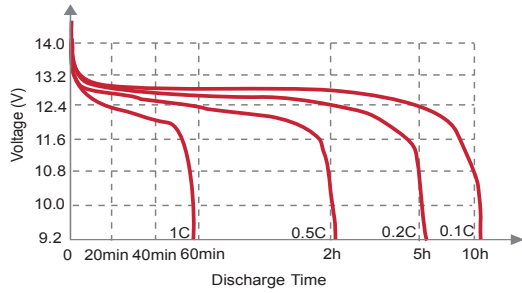

DIFFERENT TEMPERATURE DISCHARGE CURVE (0.5C)

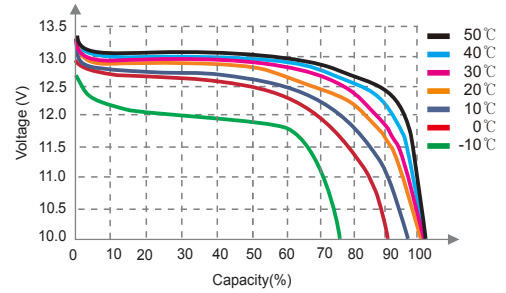

STATE OF CHARGE CURVE (0.5C, 25°C)

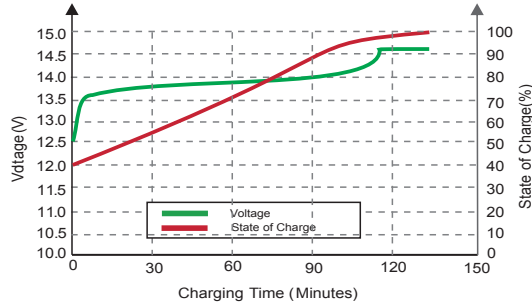

CHARGING CHARACTERISTICS (0.5C, 25°C)

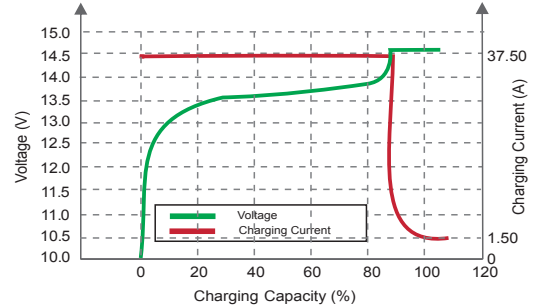

DIFFERENT DOD DISCHARGE CYCLE LIFE CURVE

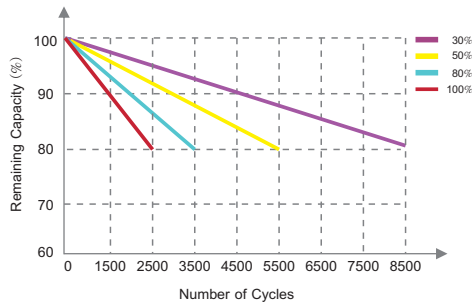

DIFFERENT TEMPERATURE SELF DISCHARGE CURVE

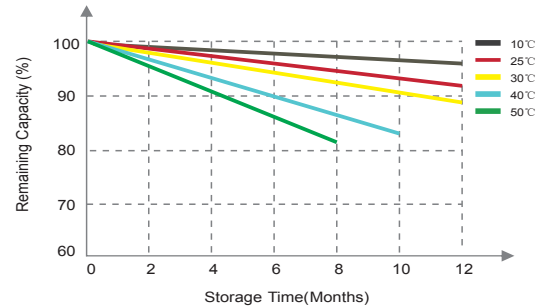

FEATURE LIFEPO4 BATTERY



MORE CAPACITY :

Lithium iron provides up to 100% of usable energy, which means you can discharge the battery entirely.



MINIMAL SELF-DISCHARGE :

Less than 3% self-discharge per month, which provides you more power when you need it.



EASY INSTALLATION :

Canbat lithium iron batteries are designed to be drop-in replacements for sealed lead-acid batteries.



LIGHTWEIGHT :

Lithium iron batteries are 60% lighter than lead-acid batteries, allowing for simple installation and transportation.



INCREASED FLEXIBILITY :

Install up to 4 lithium LiFePO4 batteries in series to increase overall voltage or up to 4 in parallel to increase amperage.



HIGH DISCHARGE RATE :

Ability to deeply discharge the battery at a high rate of discharge while maintaining high energy capacity.



INTELLIGENT BMS :

The battery management system monitors and adapts to battery conditions to maximize performance and safety.



FASTER CHARGING :

Charges much faster than conventional sealed lead-acid batteries, giving you access to reliable power quicker.



LONG CYCLE LIFE :

More than 2,500 cycles at a depth of discharge of 100% and a warranty of 10 years on all lithium batteries.