



# CANBAT



Model: CLI300-12LT | Voltage: 12.8V | Capacity: 300Ah | Energy: 3840Wh | Group: 8D

## ELECTRICAL SPECIFICATIONS

Nominal Voltage	12.8 V
Nominal Capacity	300 Ah
Capacity @ 25A	720 min
Resistance	≤30 mΩ @ 50% SOC
Efficiency	99%
Self Discharge	<3% per Month
Maximum Modules in Parallel or Series	4

## CHARGING CHARACTERISTICS

Recommended Charge Current	≤ 100 A
Maximum Charge Current	200 Ah
Floating Charge Voltage	13.8 ±0.2 V
Maximum Charge Voltage	14.6 ±0.2 V
Recommended Charge Voltage (Single Unit)	14.4 V - 14.6 V
BMS Charge Voltage Cut-Off	14.8 V
Reconnect Voltage	14.4 V
Balancing Voltage	13.6 V ± 0.2 V

## DISCHARGE SPECIFICATIONS

Maximum Continuous Discharge Current	200 A
Peak Discharge Current	450 A For 3 S
Recommended Low Voltage Disconnect	10 V ± 0.04 V
BMS Discharge Voltage Cut-Off	11 V
Reconnect Voltage	11.2 V ± 0.04 V
Short Circuit Protection	200-600 μs

## DIMENSIONAL SPECIFICATIONS

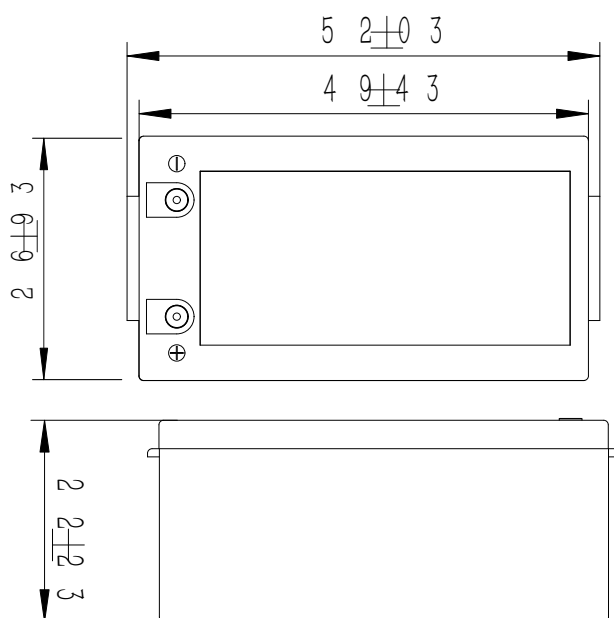

## TEMPERATURE SPECIFICATIONS

Discharge Temperature	-20 to 60 °C ( -4 to 140 °F )
Charge Temperature*	-20 to 60 °C ( -4 to 140 °F )
Recommended Storage Temperature	-5 to 35 °C ( 23 to 95 °F )
BMS High Temperature Cut-Off	65 °C ( 149 °F )
Reconnect Temperature	50 °C ( 122 °F )

BUILT-IN HEATER POWER DRAW: 180W

## MECHANICAL SPECIFICATIONS

Dimensions (L x W x H)	20.47 x 10.59 x 8.74" 520 x 269 x 222 mm
Weight	75 lbs (34.02 kg)
Terminal / Thread Pitch	M8 / 1.25
Bolt Length / Thread Depth	16mm / 10mm
Case Material / Torque	ABS / 80-100 in-lbs (9-11 N-m)
IP Rating	IP55
Cell Type - Chemistry	Prismatic - LiFePO4

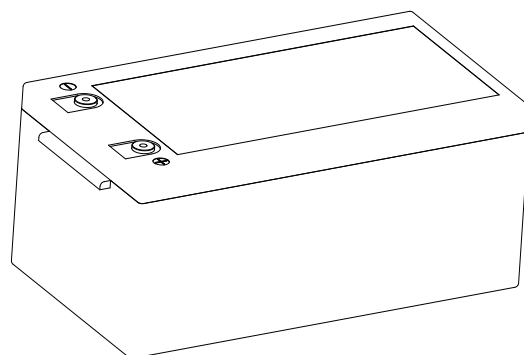

To ensure safe and efficient operation always refer to the latest edition of our datasheets, as published on our website [www.canbat.com](http://www.canbat.com). Canbat Technologies Inc. All rights reserved. All trademarks are the property of their respective owners. All data subject to change without notice. E&O.E



# CANBAT



Model: CLI300-12LT | Voltage: 12.8V | Capacity: 300Ah | Energy: 3840Wh | Group: 8D

## DIFFERENT RATE DISCHARGE CURVE (25°C)

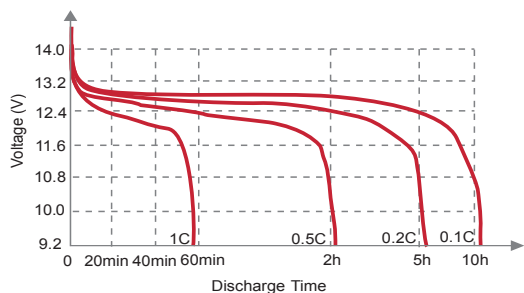

## DIFFERENT TEMPERATURE DISCHARGE CURVE (0.5C)

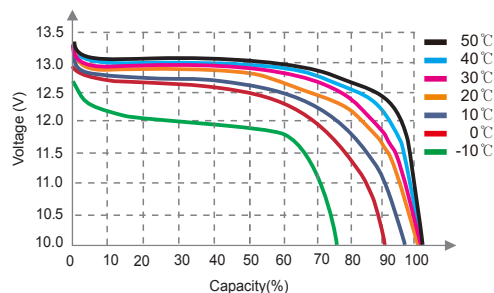

## STATE OF CHARGE CURVE (0.5C, 25°C)

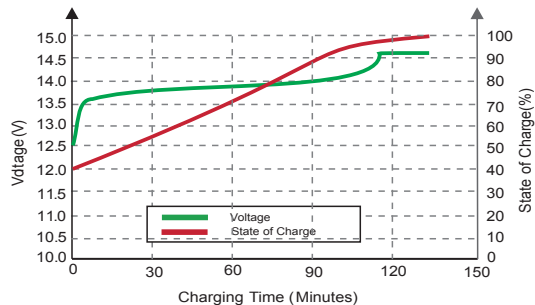

## CHARGING CHARACTERISTICS (0.5C, 25°C)

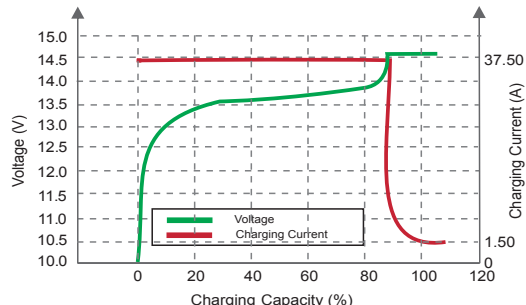

## DIFFERENT DOD DISCHARGE CYCLE LIFE CURVE

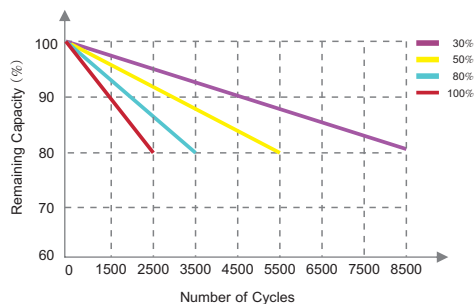

## DIFFERENT TEMPERATURE SELF DISCHARGE CURVE

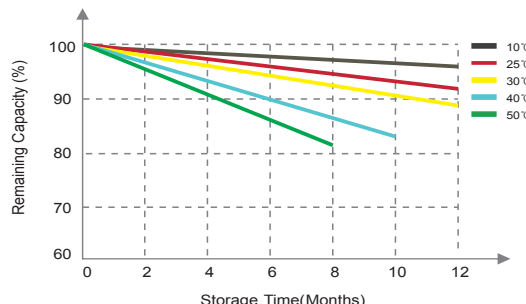

## FEATURE LIFEPO4 BATTERY



### MORE CAPACITY :

Lithium iron provides up to 100% of usable energy, which means you can discharge the battery entirely.



### LIGHTWEIGHT :

Lithium iron batteries are 60% lighter than lead-acid batteries, allowing for simple installation and transportation.



### INTELLIGENT BMS :

The battery management system monitors and adapts to battery conditions to maximize performance and safety.



### MINIMAL SELF-DISCHARGE :

Less than 3% self-discharge per month, which provides you more power when you need it.



### INCREASED FLEXIBILITY :

Install up to 4 lithium LiFePO4 batteries in series to increase overall voltage or up to 4 in parallel to increase amperage.



### FASTER CHARGING :

Charges much faster than conventional sealed lead-acid batteries, giving you access to reliable power quicker.



### EASY INSTALLATION :

Canbat lithium iron batteries are designed to be drop-in replacements for sealed lead-acid batteries.



### HIGH DISCHARGE RATE :

Ability to deeply discharge the battery at a high rate of discharge while maintaining high energy capacity.



### LONG CYCLE LIFE :

More than 2,500 cycles at a depth of discharge of 100% and a warranty of 10 years on all lithium batteries.